

# Shutter Motion



**NEW PRODUCT RELEASE** *easy self install*



CLASSIC 90 BLADE

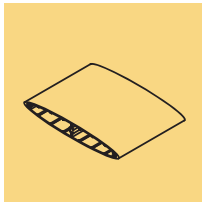

EURO 115 BLADE

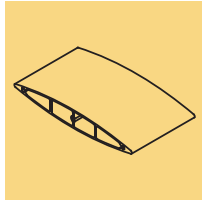

E-150 BLADE

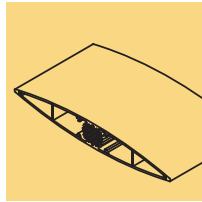

MARQUIS 200

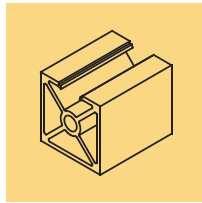

MILLENNIUM POST

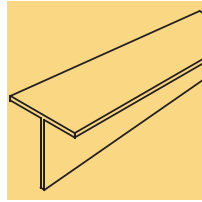

T-BRACKET

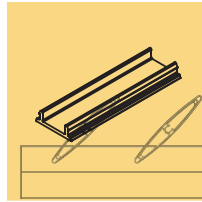

CLIP IN

MILLENNIUM SUPER POST  
50\*50mm ANODIZED OR POWDER COATED

CLASSIC 90mm BLADES (MAX. 5.9m)  
ANODIZED OR POWDER COATED  
(OPTION: 70, 115, 150mm BLADES)

## Continuous Fixed Sun Awning Systems

- Standard 45° and 30° pre notched supports
- Full length (Max. 5.9m) elliptical blades
- Colour matched endcaps
- Custom colours or anodized 25 micron 15yrs warranty
- Choice of 5 wall brackets
- Choice of 4 elliptical profile blades

T-BRACKET  
100\*100\*600mm POWDER COATED

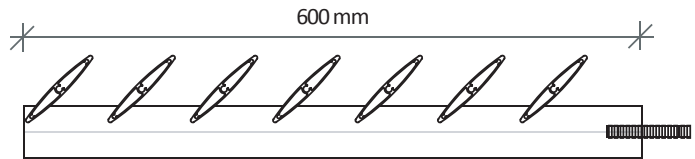
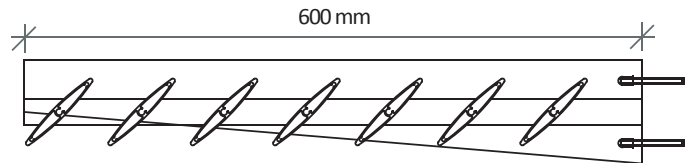

MILLENNIUM SUPER POST  
50\*50mm ANODIZED OR POWDER COATED

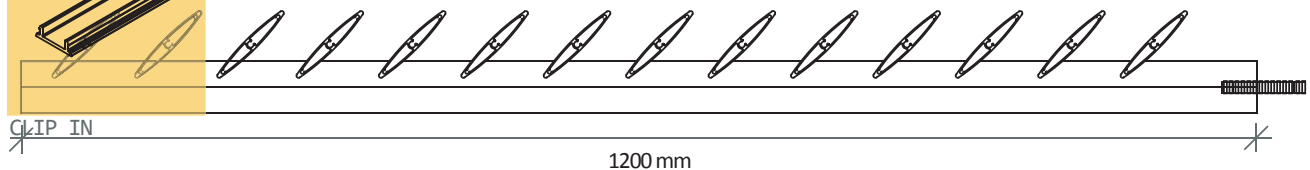

**NEW PRODUCT RELEASE** *easy self install*

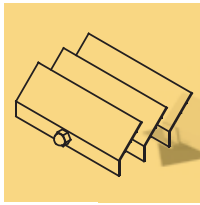

40mm SPACING

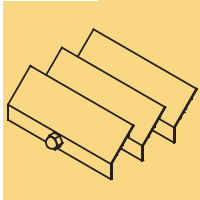

60mm SPACING

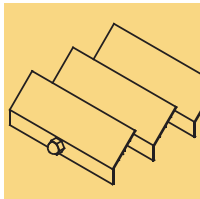

100mm SPACING

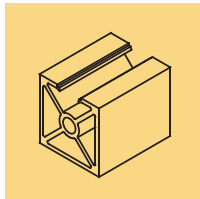

MILLENNIUM POST

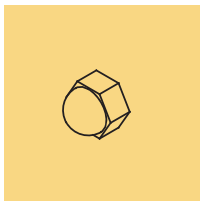

DOME NUT

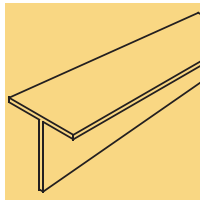

T-BRACKET

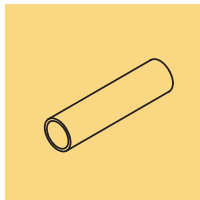

LOUVRE TUBE



6025 LOUVRES  
(OPTION: 5003 LOUVRES)

TAPERED T-BRACKET

## Accent 6025 Fixed Sun Awning Systems

- Standard 45° and 30° pre notched supports
- Full length (Max. 5.9m) elliptical blades
- Colour matched endcaps
- Custom colours or anodized 25 micron 15yrs warranty
- Choice of 5 wall brackets
- Choice of 4 elliptical profile blades

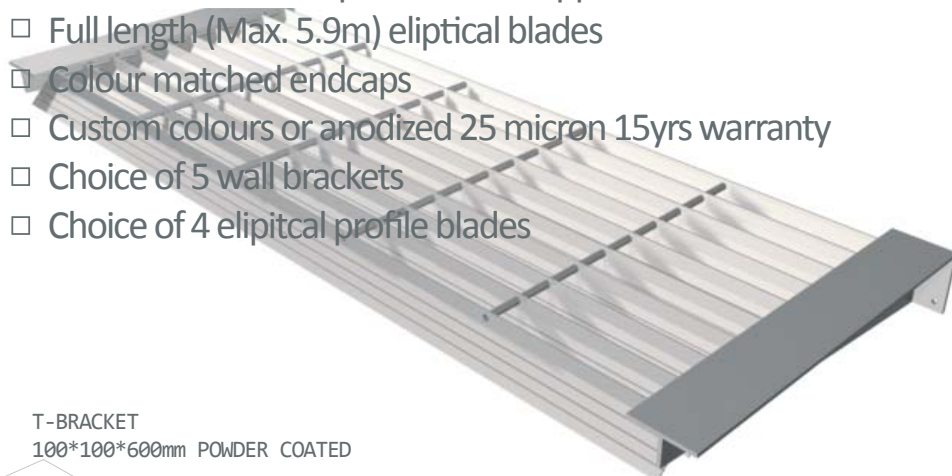

T-BRACKET  
100\*100\*600mm POWDER COATED

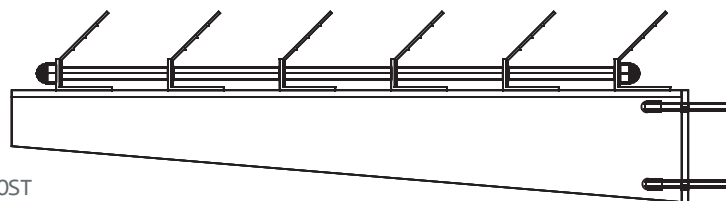
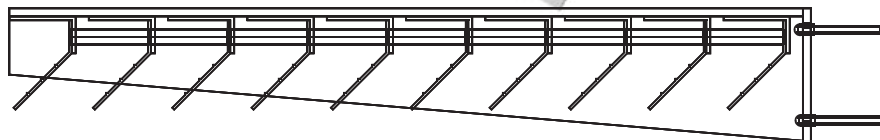

MILLENNIUM SUPER POST  
50\*50mm ANODIZED OR POWDER COATED

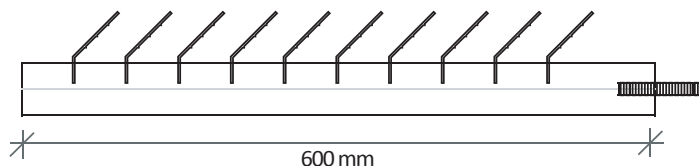

**NEW PRODUCT RELEASE** *easy self install*

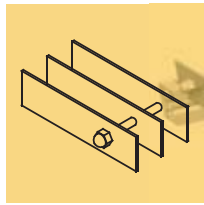

40mm SPACING

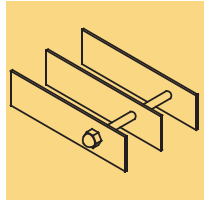

60mm SPACING

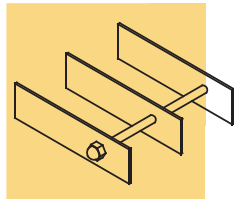

100mm SPACING

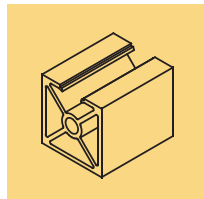

MILLENNIUM POST

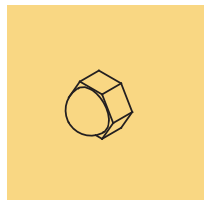

DOME NUT

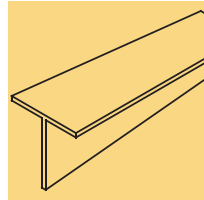

T-BRACKET

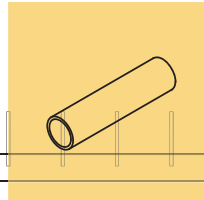

LOUVRE TUBE

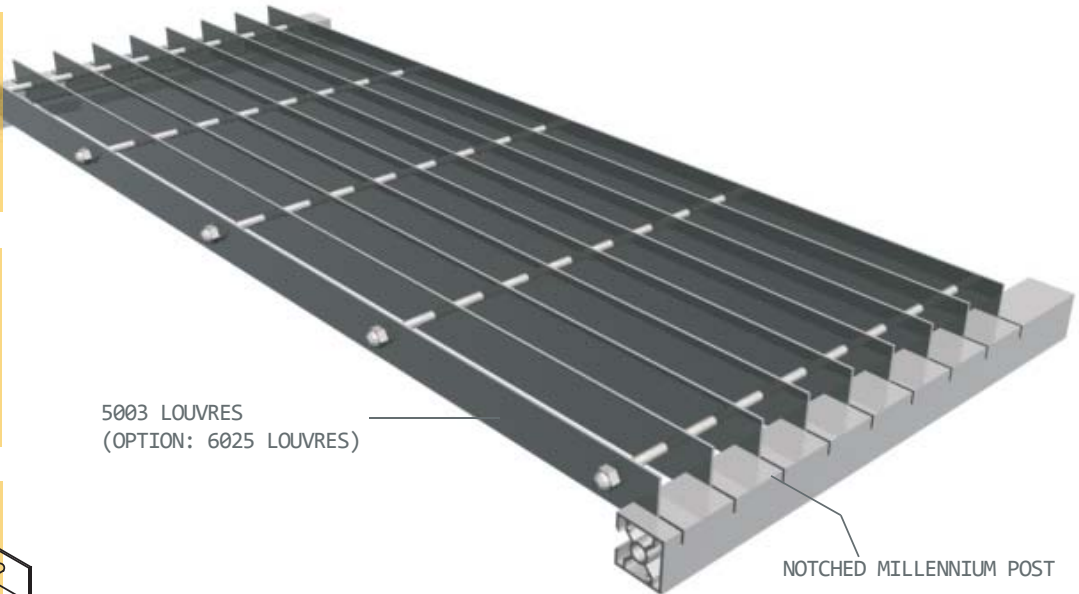

5003 LOUVRES  
(OPTION: 6025 LOUVRES)

NOTCHED MILLENNIUM POST

## Accent 5003 Fixed Sun Awning Systems

- Standard 45° and 30° pre notched supports
- Full length (Max. 5.9m) elliptical blades
- Colour matched endcaps
- Custom colours or anodized 25 micron 15yrs warranty
- Choice of 5 wall brackets
- Choice of 4 elliptical profile blades

T-BRACKET  
100\*100\*600mm POWDER COATED

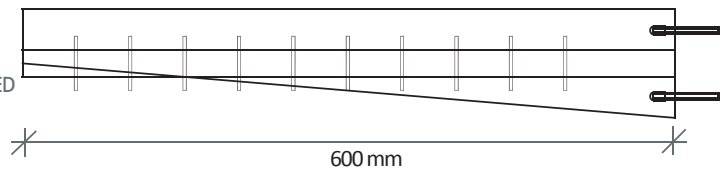

MILLENNIUM SUPER POST  
50\*50mm ANODIZED OR POWDER COATED

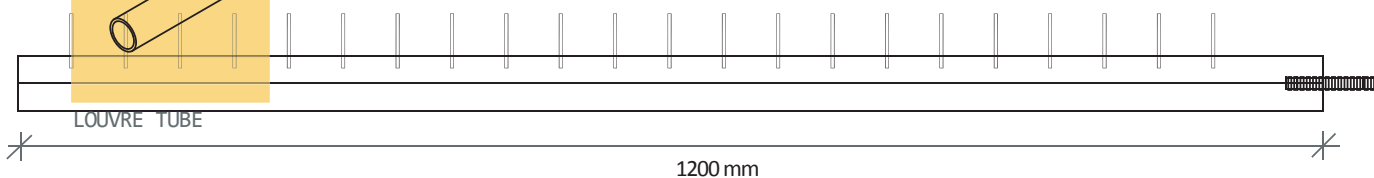
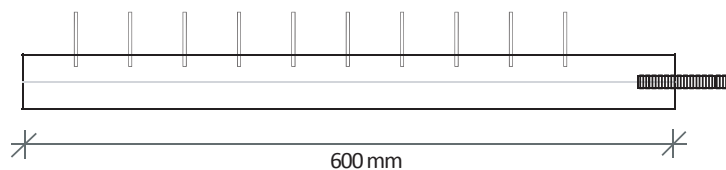

# Shutter Motion



**NEW PRODUCT RELEASE** *easy self install*



CLASSIC 90 BLADE

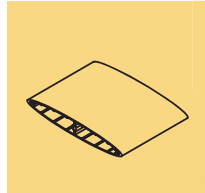

EURO 115 BLADE

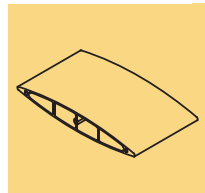

E-150 BLADE

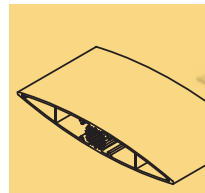

MARQUIS 200

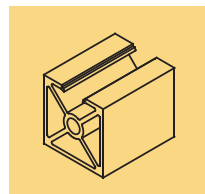

MILLENNIUM POST

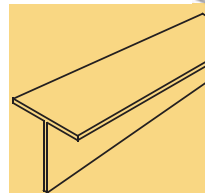

T-BRACKET

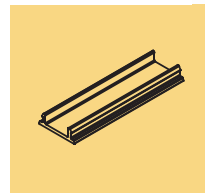

CLIP IN

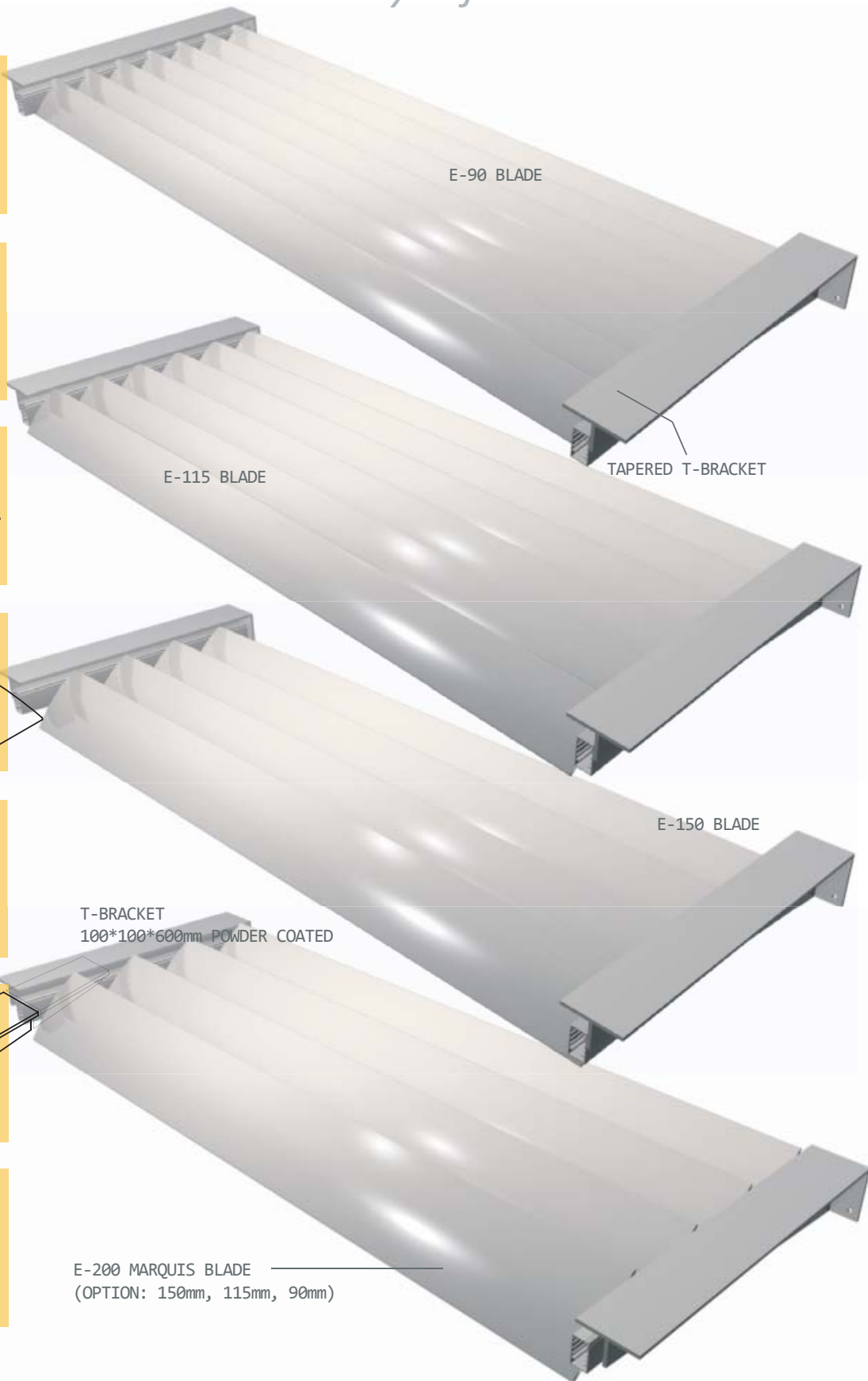

# Shutter Motion



**NEW PRODUCT RELEASE** *easy self install*



CLASSIC 90 BLADE

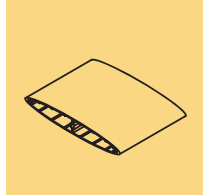

EURO 115 BLADE

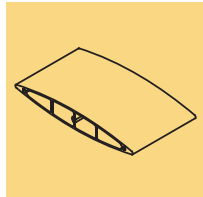

E-150 BLADE

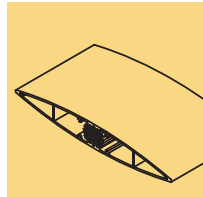

MARQUIS 200

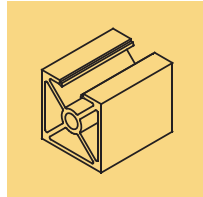

MILLENNIUM POST

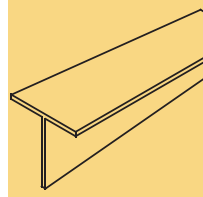

T-BRACKET

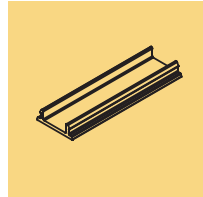

CLIP IN

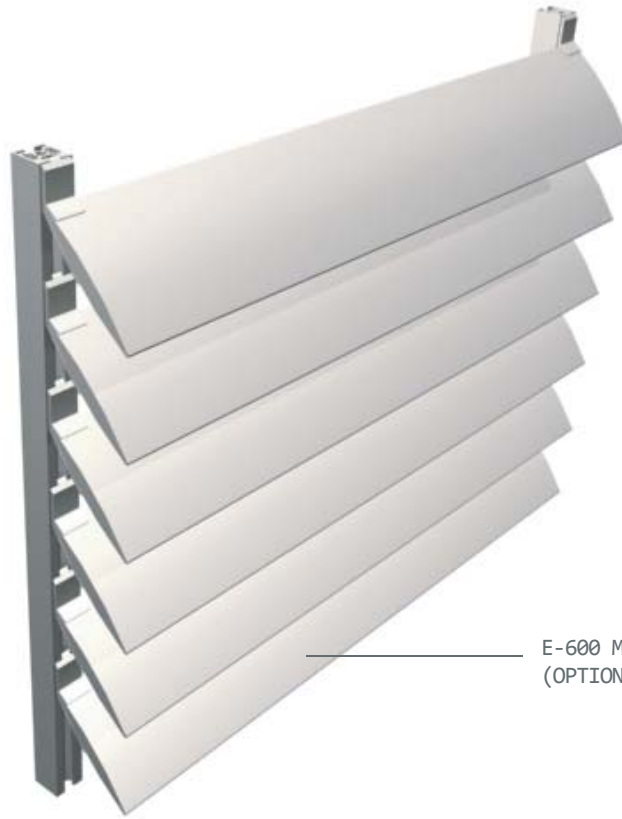

E-600 MARQUIS BLADE  
(OPTION: 450mm, 300mm, 200mm, 150mm)

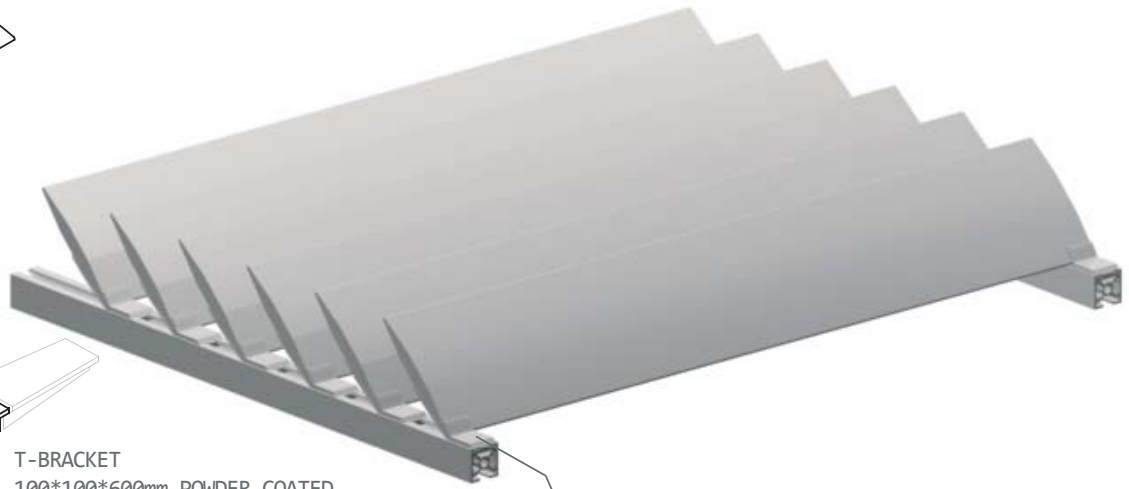

T-BRACKET  
100\*100\*600mm POWDER COATED

AERO BRACKET FITTED TO MILLENNIUM POST